



STF-25-5K

MECHANISM

TECHNICAL SPECIFICATIONS



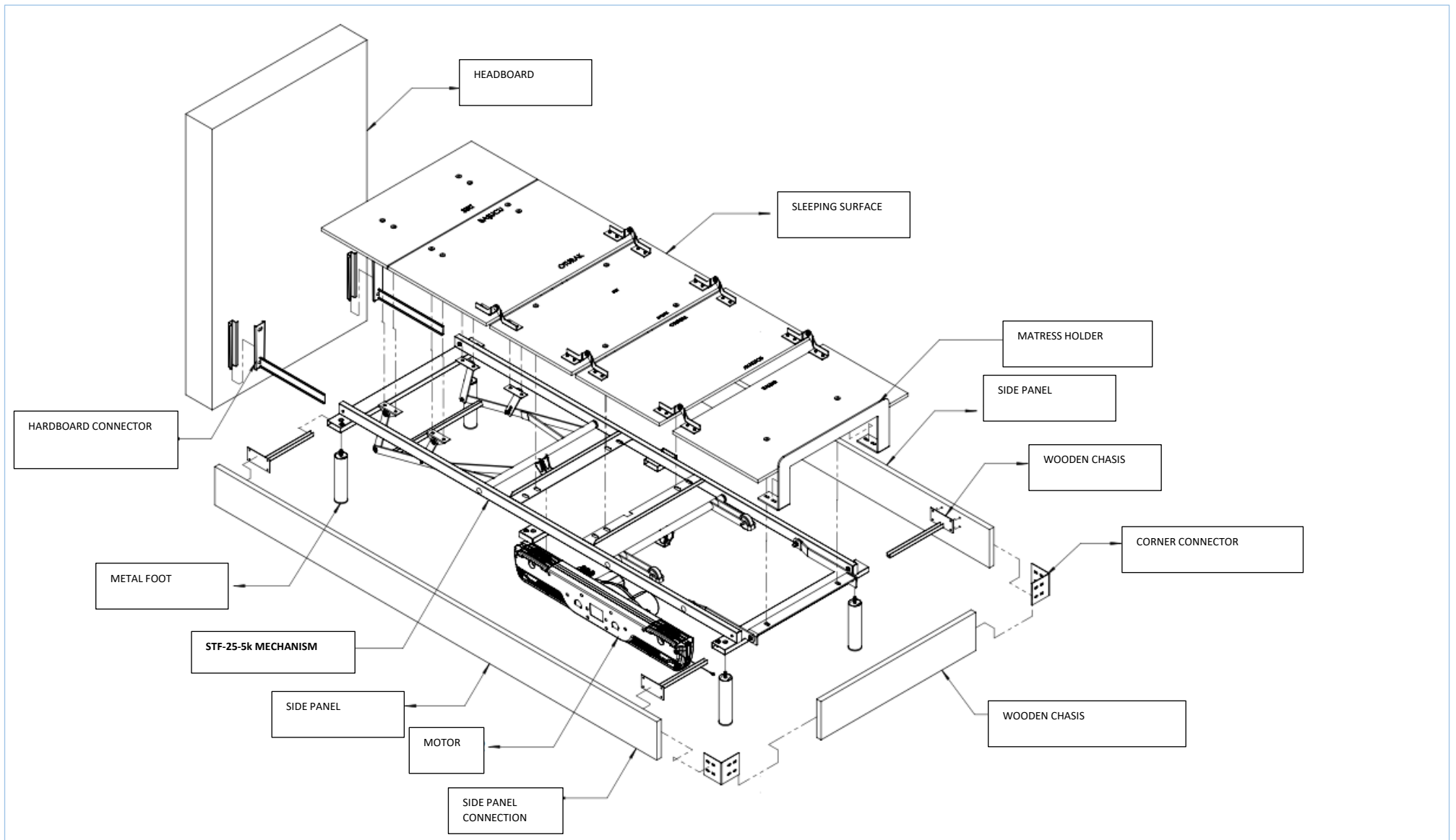

ASSEMBLY GUIDE EXAMPLE FOR STF-25-5K

STF-25-5K
70-80-90x200cm

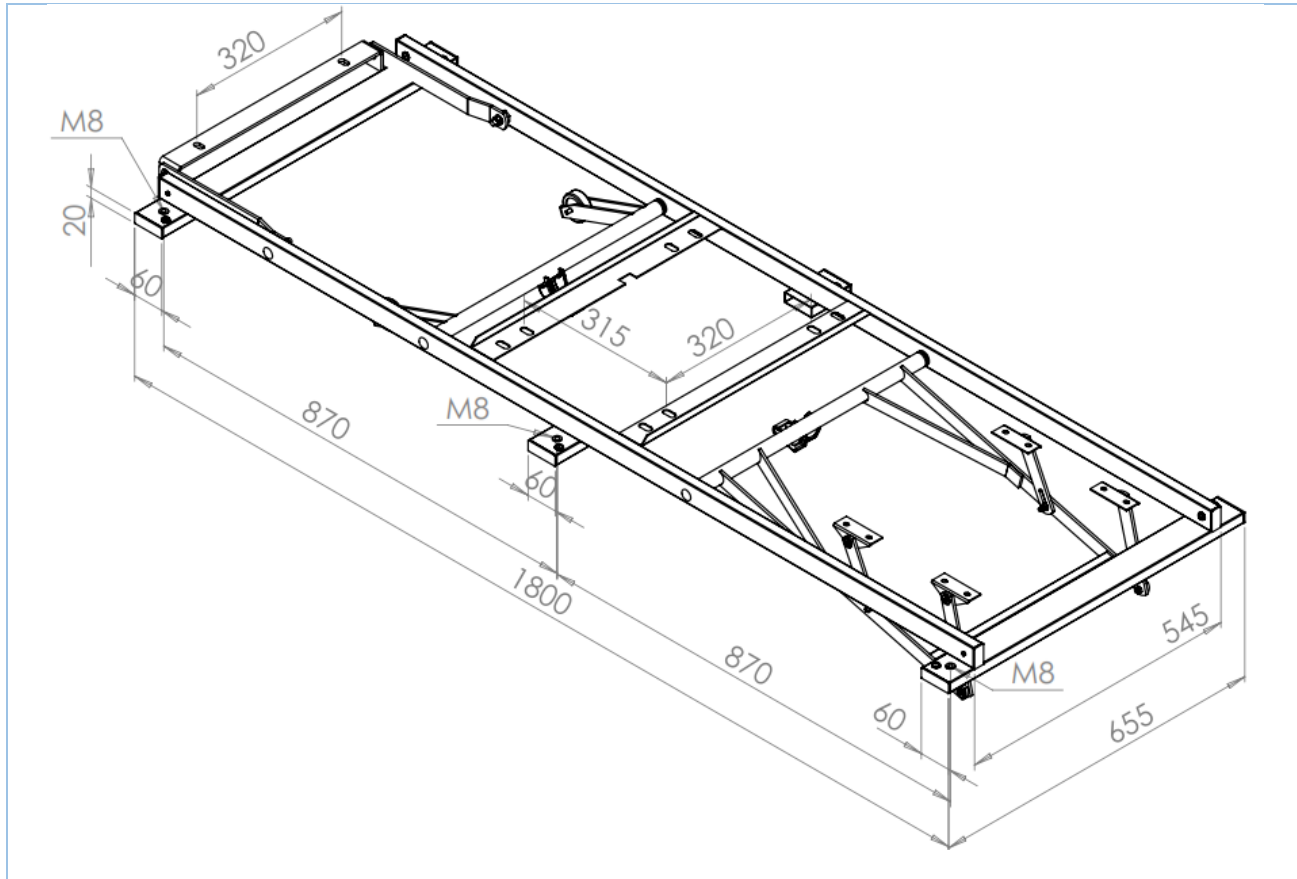

ITEM CODE	PRODUCT	H(mm)	WEIGHT (KG)
1000542	STF25-5K		



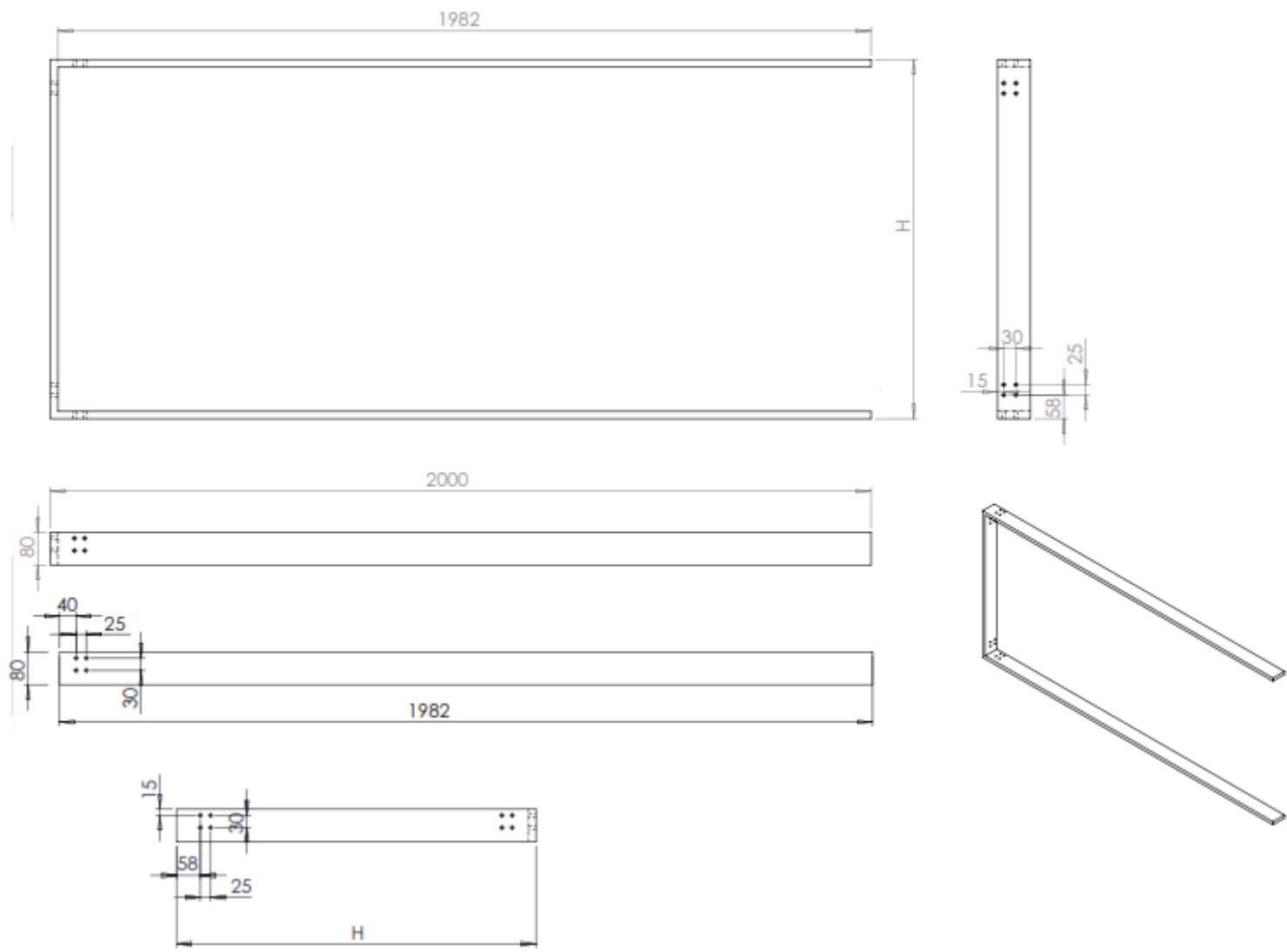

WOODEN CHASIS DETAIL